

Hygro-Thermogeber-compact

Instruction for use

1.1005.54.xxx

1.1005.64.xxx

1.1005.x4.0xx/1xx/4xx/8xx...



1.1005.x4.7xx..



1.1005.54.2xx/3xx/4xx/9xx...

Dok. No. 020891/11/21

THE WORLD OF WEATHER DATA

Safety Instructions

- Before operating with or at the device/product, read through the operating instructions. This manual contains instructions which should be followed on mounting, start-up, and operation. A non-observance might cause:
 - failure of important functions
 - endangerment of persons by electrical or mechanical effect
 - damage to objects
- Mounting, electrical connection and wiring of the device/product must be carried out only by a qualified technician who is familiar with and observes the engineering regulations, provisions and standards applicable in each case.
- Repairs and maintenance may only be carried out by trained staff or **Adolf Thies GmbH & Co. KG**. Only components and spare parts supplied and/or recommended by **Adolf Thies GmbH & Co. KG** should be used for repairs.
- Electrical devices/products must be mounted and wired only in a voltage-free state.
- **Adolf Thies GmbH & Co KG** guarantees proper functioning of the device/products provided that no modifications have been made to the mechanics, electronics or software, and that the following points are observed:
 - All information, warnings and instructions for use included in these operating instructions must be taken into account and observed as this is essential to ensure trouble-free operation and a safe condition of the measuring system / device / product.
 - The device / product is designed for a specific application as described in these operating instructions.
 - The device / product should be operated with the accessories and consumables supplied and/or recommended by **Adolf Thies GmbH & Co KG** .
 - Recommendation: As it is possible that each measuring system / device / product may, under certain conditions, and in rare cases, may also output erroneous measuring values, it is recommended using redundant systems with plausibility checks for **security-relevant applications**.

Environment

- As a longstanding manufacturer of sensors Adolf Thies GmbH & Co KG is committed to the objectives of environmental protection and is therefore willing to take back all supplied products governed by the provisions of "*ElektroG*" (German Electrical and Electronic Equipment Act) and to perform environmentally compatible disposal and recycling. We are prepared to take back all Thies products concerned free of charge if returned to Thies by our customers carriage-paid.
- Make sure you retain packaging for storage or transport of products. Should packaging however no longer be required, please arrange for recycling as the packaging materials are designed to be recycled.



Documentation

- © Copyright **Adolf Thies GmbH & Co KG**, Göttingen / Germany
- Although these operating instructions have been drawn up with due care, **Adolf Thies GmbH & Co KG** can accept no liability whatsoever for any technical and typographical errors or omissions in this document that might remain.
- We can accept no liability whatsoever for any losses arising from the information contained in this document.
- Subject to modification in terms of content.
- The device / product should not be passed on without the/these operating instructions.

Contents

1	Models Available.....	4
2	Application	6
3	Storage.....	6
3.1	Information on Storage	6
3.2	Procedure of Regeneration.....	7
3.3	Details on Supersaturation	7
4	Mounting.....	7
5	Maintenance	8
6	Connction Diagrams	8
7	Technical Data.....	14
8	Accessories / Spareparts (optional)	15
9	EC-Declaration of Conformity	16
10	UK-CA-Declaration of Conformity	17

1 Models Available

Order-No.	Measuring Range	Humidity Output	Temperature Output	Operating Voltage	Sensor protective filter	Type	Construction / Cable length
1.1005.54.000	0 ... 100% r. F. -40 ... +80°C	0 ... 1V	Pt 100	6 ... 30V DC	ZE20	Staff sensor	Cable with cable gland ¹ / 5m
1.1005.54.150	0 ... 100% r. F. -40 ... +80°C	0 ... 1V	Pt 100	6 ... 30V DC	ZE20	Staff sensor	Cable with cable gland ¹ / 25m
1.1005.54.160	0 ... 100% r. F. -30 ... +70°C	0 ... 1V	0 ... 1V	6 ... 30V DC	ZE20	Staff sensor	Cable with cable gland ¹ / 10m
1.1005.54.161	0 ... 100% r. F. -30 ... +70°C	0 ... 10V	0 ... 10V	15 ... 30V DC	ZE20	Staff sensor	Cable with cable gland ¹ / 5m
1.1005.54.165	0 ... 100% r. F. -30 ... +70°C	0 ... 1V	0 ... 1V	6 ... 30V DC	ZE20	Staff sensor	Cable with cable gland ¹ / 30m
1.1005.54.173	0 ... 100% r. F. -30 ... +70°C	0 ... 5V	0 ... 5V	10 ... 30V DC	ZE20	Staff sensor	Cable with cable gland ¹ / 5m
1.1005.54.241	0 ... 100% r. F. -30 ... +70°C	4 ... 20mA	4 ... 20mA	12 ... 30V DC ⁴	ZE20	Connecting head ³	Screw clamp cable gland ¹ / 5m cable
1.1005.54.300	0 ... 100% r. F. -40 ... +80°C	0 ... 1V	Pt 100	6 ... 30V DC	ZE21	Connecting head ³	Screw clamp cable gland ² / 5m
1.1005.54.341	0 ... 100% r. F. -30 ... +70°C	4 ... 20mA	4 ... 20mA	12 ... 30V DC ⁴	ZE20	Connecting head ³	Screw clamp cable gland ¹ / 10m
1.1005.54.360	0 ... 100% r. F. -50 ... +50°C	0 ... 1V	0 ... 1V	6 ... 30V DC	ZE20	Staff sensor	Screw clamp cable gland ¹ / 10m
1.1005.54.365	0 ... 100% r. F. -50 ... +50°C	0 ... 1V	0 ... 1V	6 ... 30V DC	ZE20	Staff sensor	Screw clamp cable gland ¹ / 15m
1.1005.54.441	0 ... 100% r. F. -40 ... +60°C	4 ... 20mA	4 ... 20mA	12 ... 30V DC ⁴	ZE20	Connecting head ³	Screw clamp cable gland ¹ / 5m
1.1005.54.448	0 ... 100% r. F. -40 ... +60°C	4 ... 20mA	4 ... 20mA	12 ... 30V DC ⁴	ZE20	Connecting head ³	Screw clamp cable gland ¹ / 8m
1.1005.54.460	0 ... 100% r. F. -40 ... +60°C	0 ... 1V	0 ... 1V	6 ... 30V DC	ZE20	Staff sensor	Cable with cable gland ¹ / 10m
1.1005.54.461	0 ... 100% r. F. -40 ... +60°C	0 ... 10V	0 ... 10V	15 ... 30V DC	ZE20	Staff sensor	Cable with cable gland ¹ / 5m
1.1005.54.700	0 ... 100% r. F. -40 ... +80°C	0 ... 1V	Pt 100	6 ... 30V DC	ZE20	Staff sensor	Plug
1.1005.54.701	0 ... 100% r. F. -40 ... +80°C	0 ... 1V	Pt 100	6 ... 30V DC	ZE20	Staff sensor	Plug with mating plug

Order-No.	Measuring Range	Humidity Output	Temperature Output	Operating Voltage	Sensor protective filter	Type	Construction / Cable length
1.1005.54.760	0 ... 100% r. F. -30 ... +70°C	0 ... 1V	0 ... 1V	6 ... 30V DC	ZE20	Staff sensor	Plug with mating plug
1.1005.54.761	0 ... 100% r. F. -30...+70°C	0 ... 10V	0 ... 10V	15 ... 30V DC	ZE20	Staff sensor	Plug with mating plug
1.1005.54.762	0 ... 100% r.F. -40 ... +60°C	0 ... 10V	0 ... 10V	15 ... 30V DC	ZE20	Staff sensor	Plug with mating plug
1.1005.54.773	0 ... 100% r. F. F. -30 ... +70°C	0 ... 5V	0 ... 5V	10 ... 30V DC	ZE20	Staff sensor	Plug with mating plug
1.1005.54.800	0 ... 100% r. F. -40 ... +80°C	0 ... 1V	Pt 100	6 ... 30V DC	ZE20	Staff sensor	Cable with cable gland ¹ / 10m
1.1005.54.941	0...100% r. F. -5 ...+50°C	4 ... 20mA	4 ... 20mA	12 ... 30V DC ⁴	ZE20	Connecting head ³	Screw clamp cable gland ¹ / 5m
1.1005.64.000	0 ... 100% r. F -40 ... +80°C	0 ... 1V	Pt 100	6 ... 30V DC	ZE21	Staff sensor	Cable with cable gland ¹ / 5m
1.1005.64.161	0 ... 100% r. F. -30 ... +70°C	0 ... 10V	0 ... 10V	15 ... 30V DC	ZE21	Staff sensor	Cable with cable gland ¹ / 5m
1.1005.64.173	0 ... 100% r. F. -30 ... +70°C	0 ... 5V	0 ... 5V	10 ... 30V DC	ZE21	Staff sensor	Cable with cable gland ¹ / 5m
1.1005.64.241	0 ... 100% r. F. -30 ... +70°C	4 ... 20mA	4 ... 20mA	12 ... 30V DC ⁴	ZE21	Connecting head ³	Screw clamp cable gland ¹ / 5m
1.1005.64.460	0 ... 100% r.F. -40 ... +60°C	0 ... 1V	0 ... 1V	6 ... 30V DC	ZE21	Staff sensor	Cable with cable gland ¹ / 10m
1.1005.64.701	0 ... 100% r. F -40 ... +80°C	0 ... 1V	Pt 100	6 ... 30V DC	ZE21	Staff sensor	Plug with mating plug

¹) Material: Brass nickel-plated

²) Material: Stainless steel 1.4571

³) Material: Aluminum

⁴) [See diagram RL](#)

2 Application

The Hygro-Thermo Transmitters of our compact series are designed to measure relative humidity, the temperature of the air and other non-aggressive gases.

The use of capacitive humidity sensors is a guarantee for:

- A high degree of long-term stability.
- Nearly linear characteristics.
- Good dynamic behaviour.
- Dewing stability.
- Low temperature coefficients.
- Low hysteresis.

The hygro-thermo transmitter is equipped with a protective filter for the sensors, depending on model (see models available).

Type: Membrane-filter with gauze ZE20 (order-no. 1.1005.54.901) for protection against dust in case of field application.

Type: sinter-filter-ZE21 made of stainless steel (order-no. 1.1005.54.902) for protection against dust, sand and high wind velocities (>5 m/s).

Remark:

For field work, it is advisable to use a „Weather and Thermal Radiation Shield“. It is optionally available as accessory.

3 Storage

3.1 Information on Storage

The Hygro-Thermo Transmitter should be stored at a room temperature and humidity of approx. 50%. Humidity should consistently change within a range from 40...70%.

The ideal case would be to store the Hygro-Thermo Transmitter in a humidity chamber that controls the humidity changes.

After a storage period of 12 months and more, it is recommendable to regenerate the transmitter before use.

If the Hygro-Thermo Transmitter is stored at a constant ambient humidity the used polymer of the humidity sensor becomes inert, i.e. it loses the capacity of responding quickly to a changed ambient humidity. This effect is reversible; a regeneration has to be carried out.

3.2 Procedure of Regeneration

- Storing of the Hygro Thermo Transmitter at 70°C and 90% rel.h. for a period of 5h.
- Afterwards, storing of Hygro Thermo Transmitter at low humidity. Exact value is not important. Period is sufficient for a short time.
- Afterwards, let the transmitter rest for 3-4 days.
- After that, carry out calibration measurement

3.3 Details on Supersaturation

The polymer cover in a capacitive humidity sensor element, acting as dielectric medium, adsorbs and desorbs water molecules, depending on the relative humidity of the immediate ambience. Up to approx. 90% rel. humidity, the permittivity, regulated by ad- and desorption of water molecules in the polymer, and thus the electric capacity, the rel. humidity in the ambience of the capacitive sensor are in a nearly linear proportion.

If the relative humidity nears saturation, the balance between ad- and desorption rate in the polymer is disturbed, water molecules are over-bonded in the polymer, and the permittivity increases disproportionately. The measurement deviation might achieve several %rel.h.

Subsequently, the transmitter may indicate a humidity value $>100\%rF$.

This effect occurs, when the transmitter is exposed to a very high humidity for a longer time. When the transmitter is stored or operated again at lower humidity values this behavior disappears.

4 Mounting

The Hygro-Thermo Transmitter is to be mounted at a place which is representative for the climate measurement. In order to minimize incorrect outdoor measurements caused by direct sun radiation and precipitation, please use a weather- and thermal radiation shield.

Instruments without weather- and thermal radiation shield can be mounted in any position. The sensor should be mounted, however, in a way that water cannot penetrate. Dew and splash water do not damage the sensor but could lead to incorrect measurements until the filter is completely dry.

The given minimum air velocities as well as the adjusted resistance for instruments with "I-output" should be observed. Deviations could lead to additional incorrect measurements as a result of self- heating.

Preferably, the sensor should be mounted vertically facing downwards to a wall (indoor application), and should be mounted horizontally facing backwards in canals.

5 Maintenance

The Hygro-Thermo Transmitter is supplied already adjusted and its characteristics remain stable for years.

Dust does not damage the humidity sensor but does influence the dynamic behaviour negatively. If the instrument is very dirty, the sensor element can be cleaned or carefully rinsed in distilled water. Make sure you do not touch the highly-sensitive sensor element.

Before cleaning the sensor elements please remove the protecting filter; it should be cleaned, as well or should be replaced.

Attention:

The instrument housing with the electronics included should be opened only in the factory.

6 Connection Diagrams

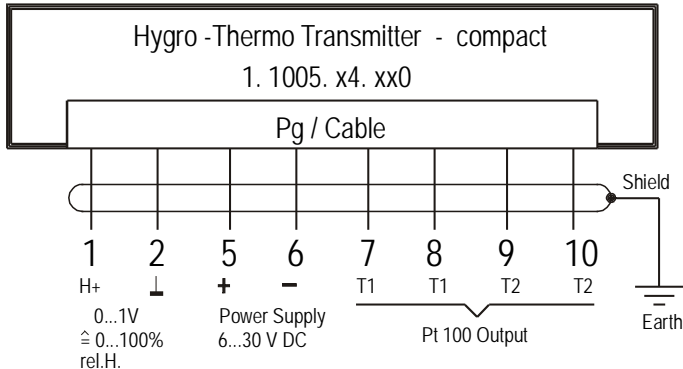
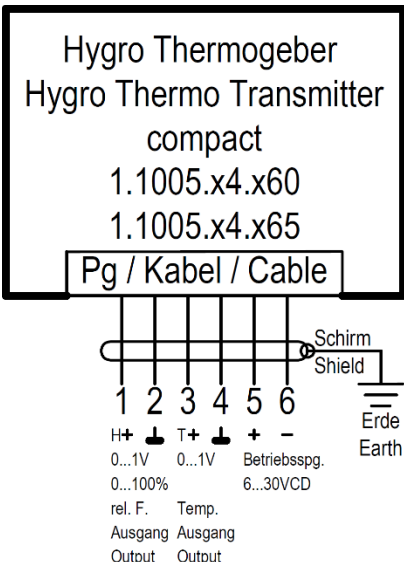
<p>1.1005.54.000 1.1005.54.150 1.1005.54.300 1.1005.54.800 1.1005.64.000</p>	
<p>1.1005.54.160 1.1005.54.165 1.1005.54.360 1.1005.54.365 1.1005.54.460 1.1005.64.460</p>	

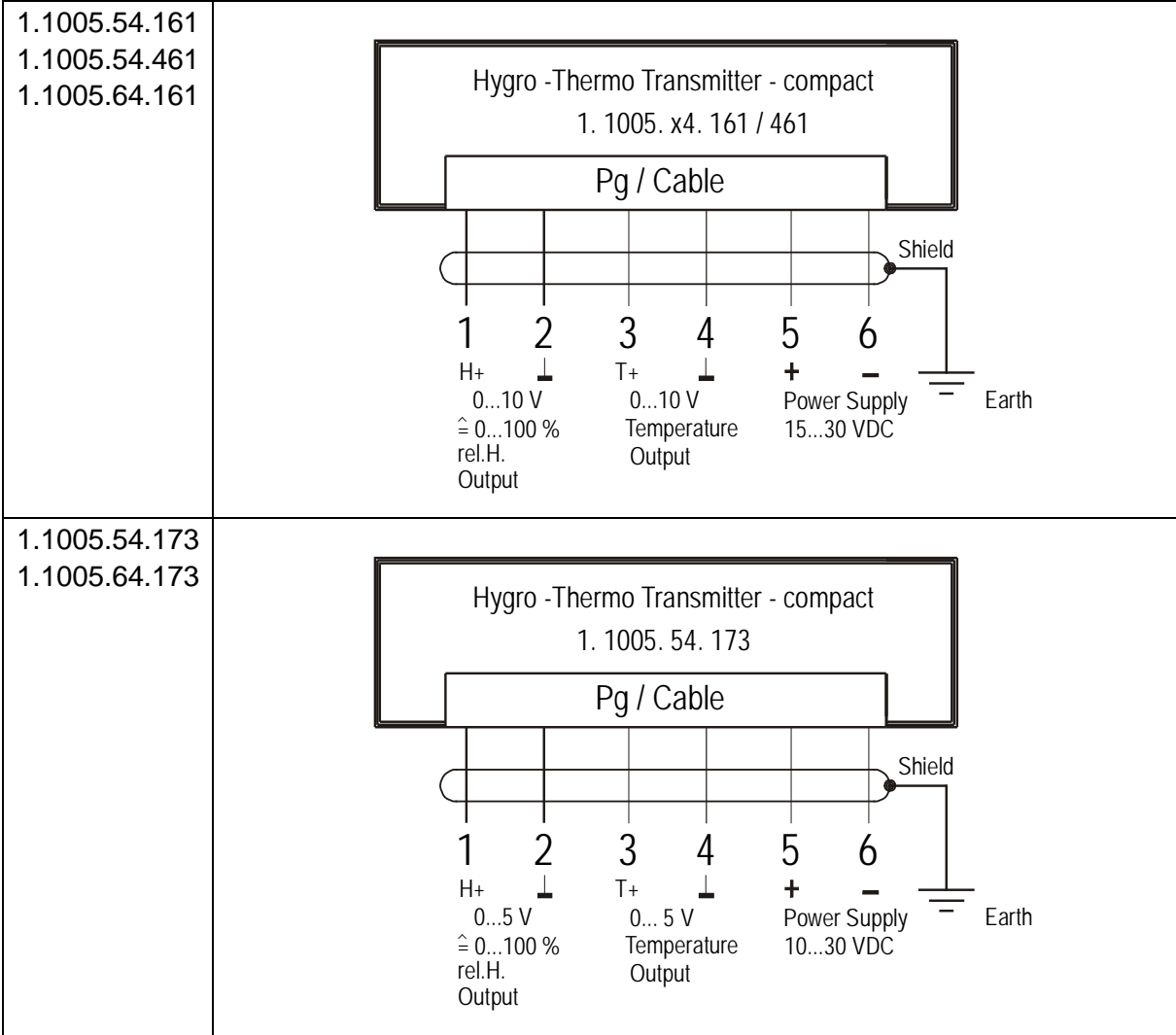

1.1005.54.241
1.1005.54.341
1.1005.54.441
1.1005.54.448
1.1005.54.941
1.1005.64.241

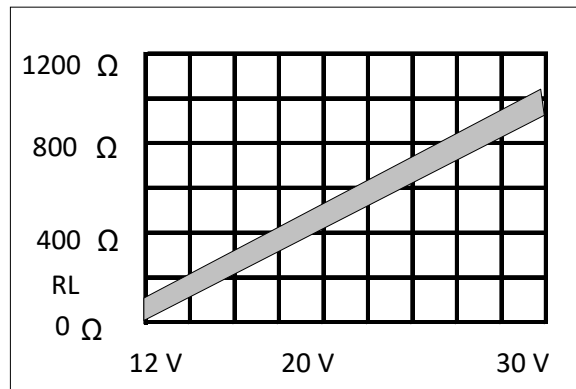
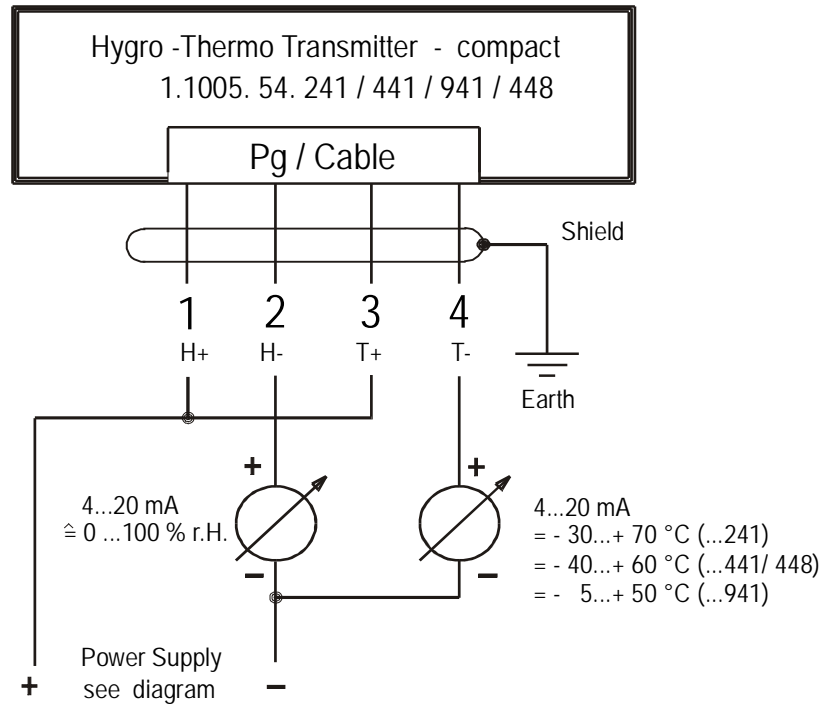
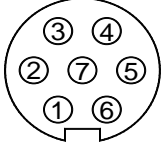
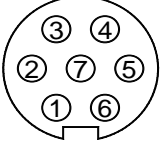
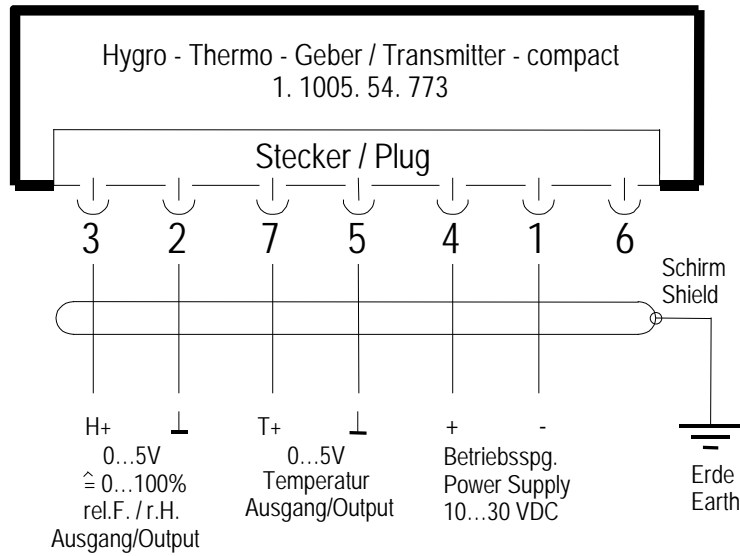

Diagram RL as a function of power supply

<p>1.1005.54.760</p>	<p style="text-align: center;">Hygro - Thermo - Geber / Transmitter - compact 1. 1005. 54. 760</p> <p style="text-align: center;">Stecker / Plug</p> <p style="text-align: center;">3 2 7 5 4 1 6</p> <p style="text-align: center;">Schirm Shield</p> <p style="text-align: center;">Erde Earth</p> <p>H+ 0...1V ≅ 0...100% rel.F. / r.H. Ausgang/Output</p> <p>T+ 0...1V Temperatur Ausgang/Output</p> <p>+ - Betriebsspg. Power Supply 6...30 VDC</p>	<p>Position of pins</p> 
<p>1.1005.54.761 1.1005.54.762</p>	<p style="text-align: center;">Hygro - Thermo - Geber / Transmitter - compact 1. 1005. 54.761 / 762</p> <p style="text-align: center;">Stecker / Plug</p> <p style="text-align: center;">3 2 7 5 4 1 6</p> <p style="text-align: center;">Schirm Shield</p> <p style="text-align: center;">Erde Earth</p> <p>H+ 0...10V ≅ 0...100% rel.F. / r.H. Ausgang/Output</p> <p>T+ 0...10V Temperatur Ausgang/Output</p> <p>+ - Versorgung Power Supply 15...30 VDC</p>	<p>Position of pins</p> 

1.1005.54.773



Position of
pins

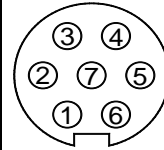

1.1005.54.700
1.1005.54.701
1.1005.64.701

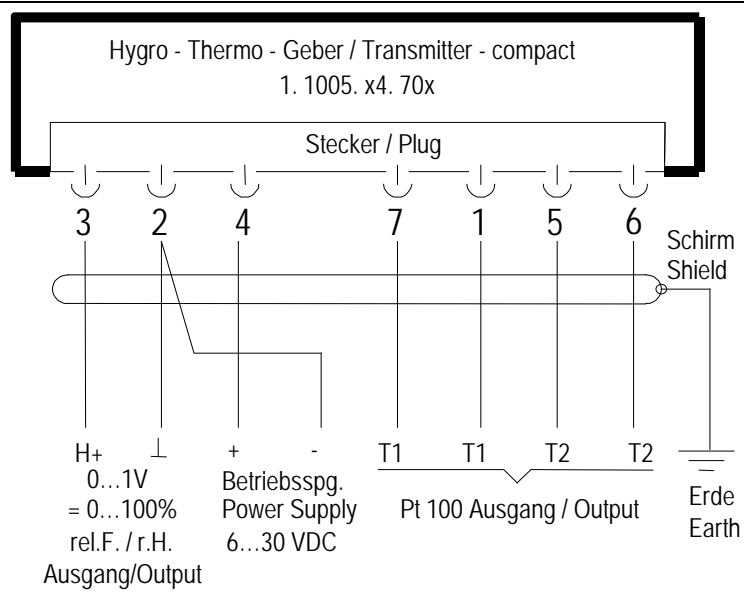

Lage der Anschlüsse

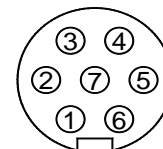
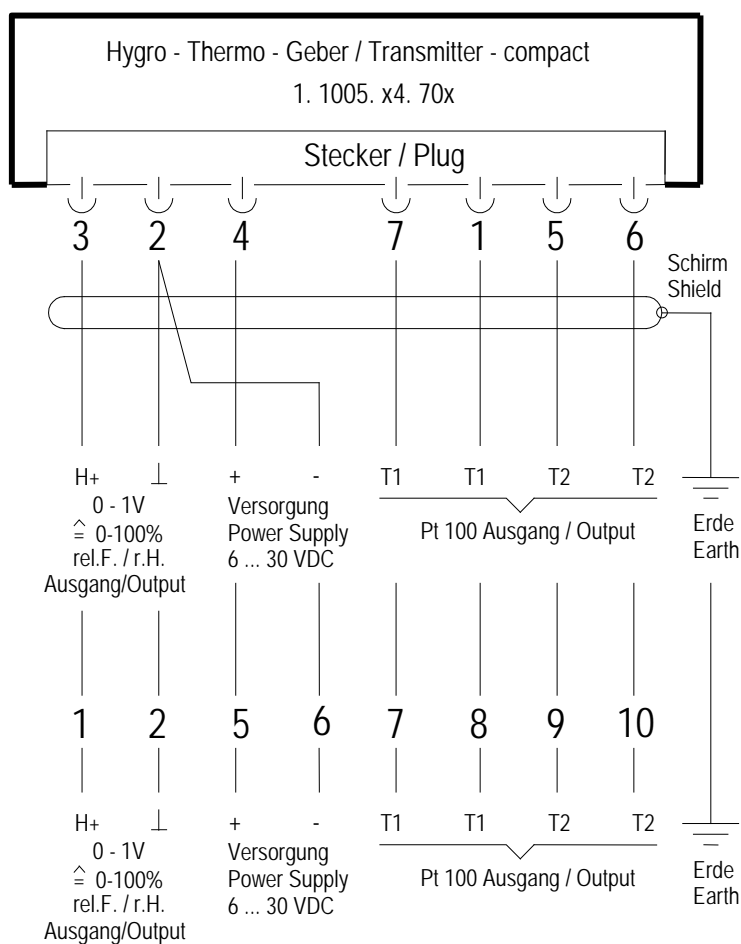

Fig. with additional cable assembly
0.1005.54.904



7 Technical Data

Humidity	
Measuring element	Capacitive
Measuring range	0 ... 100% rel. humidity
Deviation	±2% rel. humidity @ 5 ... 95% rel.h. / 10 ... 40°C
Add. Error (<10°C, >40°C)	<0,1%/K
Long-term stability	<1% r. h. / a
Response Time (T 90)	<20s @ v = 1,5m/s w/o filter
	<1.5min. @ v = 1,5m/s with Membrane filter ZE 20
	<1.5min. @ v = 1,5m/s with Sinter filter ZE 21
Temperature	
Measuring element	Pt 100 Class B, 1/3 DIN tolerance
Measuring range	See models available.
Deviation	±0,1K @ Output Pt 100, 1/3 DIN
	±0,2K @ Output 0 ... 10V
	±0,3K @ Output 4 ... 20mA
Add. error (<10°C, >40°C)	±0.0073K/K
Response time (T 90)	<20s @ v = 1.5m/s w/o filter
	<1.5min. @ v = 1.5m/s with Membrane filter ZE 20
	<1.5min. @ v = 1.5m/s with Sinter filter ZE 21
Additional Specifications	
Ambient temperature	-40 ... +80°C
Protection sensor	IP 30
Protection electronics, connecting head	IP 65
Operating voltage	12 ... 30V DC @ 4 ... 20mA Output
	15 ... 30V DC @ 0 ... 10V Output
	10 ... 30V DC @ 0 ... 5V Output
	6 ... 30V DC @ 0 ... 1V Output
Load resistor	I-output: See diagram RL
	≥10kΩ @ U-Output (0 ... 10V / 0 ... 5V)
	≥2 kΩ @ U-Output (0 ... 1V):
Instrument current requirements	approx.. 5mA @ humidity/temperature(0 .. 10V / 0..5V)
	<1mA @ humidity (0 ... 1V):
Minimum air velocity (transversally to the sensor)	≥0,5m/s @ 0 ... 10V; 2x 0 ... 1V Output
	≥1,0m/s @ 4 ... 20mA; 2x 0 ... 10V Output
	≥1,5m/s @ 2 x 4 ... 20mA Output

Dimension to model 1005.54(64).000 / 150 / 160 / 164 / 161 / 173 / 360 / 365 / 460 / 461 / 800	
Diameter / Shaft length / Total length	20mm / 12 2mm / 145mm
Dimension to model 1.1005.54(64).241 / 341 / 300 / 441 / 448 / 941	
Diameter / Shaft length / Total length	20mm / 122mm / 180mm
Dimension to model 1.1005.54(64).701 / 760 / 761 / 762 / 773	
Diameter / Shaft length / Total length	20mm / 155mm / 195mm
Dimension to model 1.1005.54.700	
Diameter / Shaft length	20mm / 155mm

8 Accessories / Spareparts (optional)

<p>Weather and Thermal Radiation Shield</p> <p>The use of the Weather and Thermal Radiation Shield in an appropriate combination with suitable temperature and humidity sensors reduces to a minimum the possibility of influencing the data in a negative manner by radiation, precipitation or damage.</p> <p>More exactly measuring results are achieved by using the ventilated Weather and Thermal Radiation Shield (mod. 1.1025.55.10x with ventilation). The ventilation reduces those errors which might occur during the measurements in a weather hut caused by the so-called „proper climate“.</p>	<p>1.1025.55.00x .10x .xx0 .xx1</p>	<p>w/o ventilator with ventilator 12V DC / 2W , incl. 5m cable for mast tube mounting \varnothing 30 ... 50mm for mast tube mounting \varnothing 55 ... 60mm</p> <p>dimensions: \varnothing 120 x 290mm</p> <p>Remark: It is recommendable to use the weather and thermal radiation shield-compact with ventilation order-no. 1.1025.55.10x for Hygro-Thermo Transmitter model ..241 / 441 / 300 / 941 (4 ...20mA)</p>
<p>Membrane-filter with gauze ZE20</p> <p>The filter serves for protecting the sensor elements of the Hygro-thermo transmitter against dust in case of field application.</p>	<p>1.1005.54.901</p>	<p>Material: PTFE / stainless steel Dimensions: \varnothing 20 x 25mm</p>
<p>Sinter filter ZE21</p> <p>The fine-pore sinter filter serves to protect the sensor elements of the Hygro-Thermo-Transmitter <i>compact</i> against high wind speeds (>5m/s) and dust...</p>	<p>1.1005.54.902</p>	<p>Material: stainless steel Dimensions: \varnothing 20 x 25mm</p>

9 EC-Declaration of Conformity

Manufacturer: Adolf Thies GmbH & Co. KG
 Hauptstraße 76
 37083 Göttingen, Germany
<http://www.thiesclima.com>

Product: Temperature Transmitter

Doc. Nr. 702-44503_CE

Article Overview:

1.1005.49.960	1.1005.51.600	1.1005.54.000	1.1005.54.150	1.1005.54.160	1.1005.54.161	1.1005.54.165	1.1005.54.173	1.1005.54.241	1.1005.54.300
1.1005.54.341	1.1005.54.360	1.1005.54.365	1.1005.54.441	1.1005.54.448	1.1005.54.460	1.1005.54.461	1.1005.54.500	1.1005.54.700	1.1005.54.701
1.1005.54.703	1.1005.54.741	1.1005.54.743	1.1005.54.761	1.1005.54.773	1.1005.54.780	1.1005.54.789	1.1005.54.781	1.1005.54.782	1.1005.54.790
1.1005.54.800	1.1005.54.941	1.1005.54.961	1.1005.64.000	1.1005.64.161	1.1005.64.174	1.1005.64.241	1.1005.64.460	1.1005.64.701	

The indicated products correspond to the essential requirement of the following European Directives and Regulation:

2014/30/EU	26.02.2014	DIRECTIVE 2014/30/EU OF THE EUROPEAN PARLIAMENT AND OF THE COUNCIL of 26 February 2014 on the harmonisation of the laws of the Member States relating to electromagnetic compatibility.
2014/35/EU	26.02.2014	DIRECTIVE 2014/35/EU OF THE EUROPEAN PARLIAMENT AND OF THE COUNCIL of 26 February 2014 on the harmonisation of the laws of the Member States relating to the making available on the market of electrical equipment designed for use within certain voltage limits.
2017/2102/EU	15.11.2017	DIRECTIVE (EU) 2017/2102 of the European Parliament and of the Council of November 15, 2017 amending Directive 2011/65/EU on the restriction of the use of certain hazardous substances in electrical and electronic equipment.
2012/19/EU	13.08.2012	DIRECTIVE 2012/19/EU OF THE EUROPEAN PARLIAMENT AND OF THE COUNCIL of 4 July 2012 on waste electrical and electronic equipment (WEEE).
2018/1139/EU	04.07.2018	Regulation (EU) 2018/1139 of the European Parliament and of the Council of 4 July 2018 on common rules in the field of civil aviation and establishing a European Union Aviation Safety Agency.

The indicated products comply with the regulations of the directives. This is proved by the compliance with the following standards:

DIN EN 61000-6-2	2019-11	Electromagnetic compatibility immunity for industrial environment
DIN EN 61000-6-3	2012-11	Electromagnetic compatibility (EMC). Generic standards. Emission standard for residential, commercial and light-industrial environments
DIN EN 61010-1	2020-03	Safety requirements for electrical equipment for measurement, control, and laboratory use. General requirements
DIN EN 63000	2019-05	Technical documentation for the assessment of electrical and electronic products with respect to the restriction of hazardous substances.

This declaration of conformity is issued under the sole responsibility of the manufacturer.

Legally binding signature:



General Manager - Dr. Christoph Peper

Legally binding signature:



Development Manager - ppa. Jörg Peterleit

This declaration certifies the compliance with the mentioned directives, however does not include any warranty of characteristics. Please pay attention to the security advises of the provided instructions for use.

10 UK-CA-Declaration of Conformity

Manufacturer: Adolf Thies GmbH & Co. KG
 Hauptstraße 76
 37083 Göttingen, Germany
<http://www.thiesclima.com>

Product: Temperature Transmitter

Doc. Nr. 702-44503_CA

Article Overview:

1.1005.49.960	1.1005.51.600	1.1005.54.000	1.1005.54.150	1.1005.54.160	1.1005.54.161	1.1005.54.165	1.1005.54.173	1.1005.54.241	1.1005.54.300
1.1005.54.341	1.1005.54.360	1.1005.54.365	1.1005.54.441	1.1005.54.448	1.1005.54.460	1.1005.54.461	1.1005.54.500	1.1005.54.700	1.1005.54.701
1.1005.54.703	1.1005.54.741	1.1005.54.743	1.1005.54.761	1.1005.54.773	1.1005.54.780	1.1005.54.789	1.1005.54.781	1.1005.54.782	1.1005.54.790
1.1005.54.800	1.1005.54.941	1.1005.54.961	1.1005.64.000	1.1005.64.161	1.1005.64.174	1.1005.64.241	1.1005.64.460	1.1005.64.701	

The indicated products correspond to the essential requirement of the following European Directives and Regulations:

1091	08.12.2016	The Electromagnetic Compatibility Regulations 2016
1101	08.12.2016	The Electrical Equipment (Safety) Regulations 2016
RoHS Regulations 2	01.01.2021	The Restriction of the Use of Certain Hazardous Substances in Electrical and Electronic Equipment Regulations 2012
3113	01.01.2021	Regulations: waste electrical and electronic equipment (WEEE)
2018/1139/EU	04.07.2018	Regulation (EU) 2018/1139 of the European Parliament and of the Council of 4 July 2018 on common rules in the field of civil aviation and establishing a European Union Aviation Safety Agency.

The indicated products comply with the regulations of the directives. This is proved by the compliance with the following standards:

BS EN IEC 61000-6-2	25.02.2019	Electromagnetic compatibility (EMC). Generic standards. Immunity standard for industrial environments
BS EN IEC 61000-6-3	30.03.2021	Electromagnetic compatibility (EMC). Generic standards. Emission standard for equipment in residential environments
BS EN 61010-1+A1	31.03.2017	Safety requirements for electrical equipment for measurement, control, and laboratory use. General requirements
BS EN IEC 63000	10.12.2018	Technical documentation for the assessment of electrical and electronic products with respect to the restriction of hazardous substances

This declaration of conformity is issued under the sole responsibility of the manufacturer.

Legally binding signature:



General Manager - Dr. Christoph Peper

Legally binding signature:



Development Manager - ppa. Jörg Petereit

This declaration certifies the compliance with the mentioned directives, however does not include any warranty of characteristics. Please pay attention to the security advises of the provided instructions for use.

**Please contact us for your system requirements.
We advise you gladly.**

ADOLF THIES GMBH & CO. KG

Meteorologie und Umweltmesstechnik
Hauptstraße 76 · 37083 Göttingen · Germany
Tel. +49 551 79001-0 · Fax +49 551 79001-65
info@thiesclima.com

www.thiesclima.com

